

Call To Order: 800-398-5471

Or visit our web site:

www.chargeaircoolers.com

**MACK**

**FLEET AIR PART #.....MK14A**

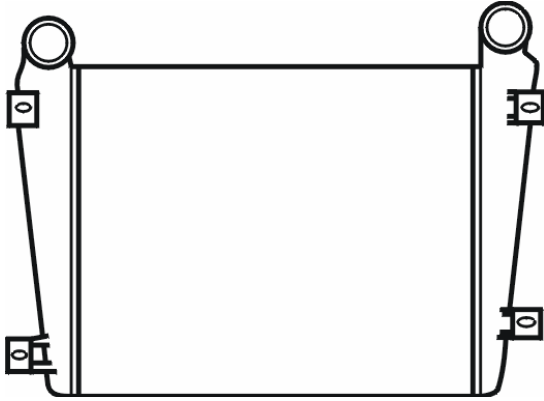

**Dimensional Data: MK14A**

INCHES	CORE SIZE	MM
28.346"	Width	720
25.196"	Height	640
3.000"	Core Thickness	75
4.000"	Inlet Connection	100
4.000"	Outlet Connection	100

**Truck Type:**

Model	Years
RW & MH	1985—1988

**Replaces These OEM Part Numbers:**

Manufacturer	OEM #
N.A.	N.A.

**Ordering Information:**

	<b>AeroSeal</b>	<b>Turbo-Max</b>
Order #	MK14A-FA01	MK14A-FA02
Price		

**FLEET AIR PART #.....MK14B**

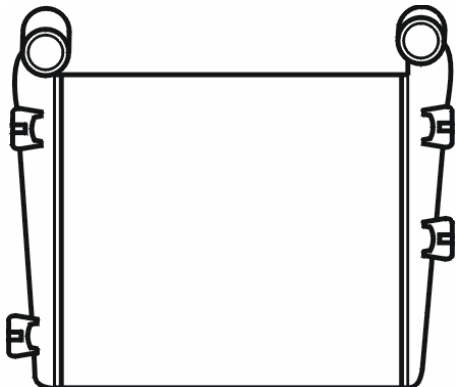

**Dimensional Data: MK14B**

INCHES	CORE SIZE	MM
38.346"	Width	720
25.196"	Height	640
3.000"	Core Thickness	75
4.000"	Inlet Connection	100
4.000"	Outlet Connection	100

**Truck Type:**

Model	Years
RW, MH, & CL	1989 and up

**Replaces These OEM Part Numbers:**

Manufacturer	OEM #
Valeo	1030047
Mack	3MD19M, 3MD514M
Mack	3MD514AM
Dimand Reo	1651FF2-13

**Ordering Information:**

	<b>AeroSeal</b>	<b>Turbo-Max</b>
Order #	MK14B-FA01	MK14B-FA02
Price		

Call To Order: 800-398-5471

Or visit our web site:

www.chargeaircoolers.com

# MACK

## FLEET AIR PART #.....MK14C

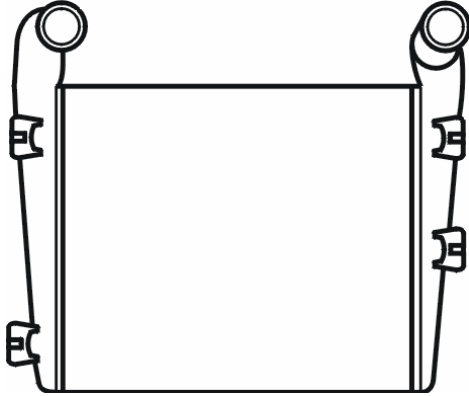

**Dimensional Data: MK14C**

INCHES	CORE SIZE	MM
28.346"	Width	720
25.196"	Height	640
3.000"	Core Thickness	75
4.000"	Inlet Connection	100
4.000"	Outlet Connection	100

### Truck Type:

Model	Years
DM	1985—1988

### Replaces These OEM Part Numbers:

Manufacturer	OEM #
Blackstone	1030013
Valeo	1030013
Mack	3MD18M, 3MD57AM
Mack	204SX272
Mack	3MD57M (has slotted brackets)

### Ordering Information:

	<b>AeroSeal</b>	<b>Turbo-Max</b>
Order #	MK14C-FA01	MK14C-FA02
Price		

## FLEET AIR PART #.....MK14D

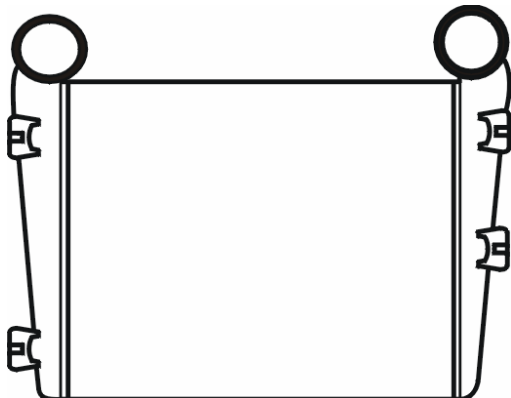

**Dimensional Data: MK14D**

INCHES	CORE SIZE	MM
28.346"	Width	720
25.196"	Height	640
3.000"	Core Thickness	75
4.125"	Inlet Connection	104
4.125"	Outlet Connection	104

### Truck Type:

Model	Years
Superliner	
Has "O" Ring Connection	

### Replaces These OEM Part Numbers:

Manufacturer	OEM #
Valeo	1030006, 1030008
Mack	204SX217
Mack	3MD55AM, 3MD16M
Mack	3MD528M
Garrett	464-120-11

### Ordering Information:

	<b>AeroSeal</b>	<b>Turbo-Max</b>
Order #	MK14D-FA01	MK14D-FA02
Price		

Call To Order: 800-398-5471

Or visit our web site:

www.chargeaircoolers.com

**MACK**

**FLEET AIR PART #.....MK14E**

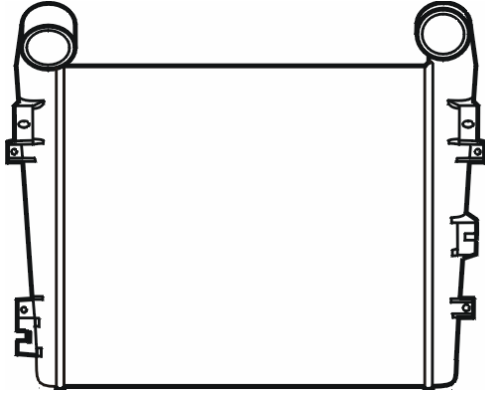

**Dimensional Data: MK14E**

INCHES	CORE SIZE	MM
28.125"	Width	714
25.375"	Height	644
2.500"	Core Thickness	63
4.000"	Inlet Connection	100
4.000"	Outlet Connection	100

**Truck Type:**

Model	Years

**Replaces These OEM Part Numbers:**

Manufacturer	OEM #
Mack	3MD534M, 3MD535AM
Mack	3MD536M
Valeo	1030146
Mack	204SX273

**Ordering Information:**

	<b>AeroSeal</b>	<b>Turbo-Max</b>
Order #	MK14E-FA01	MK14E-FA02
Price		

**FLEET AIR PART #.....MK16A**

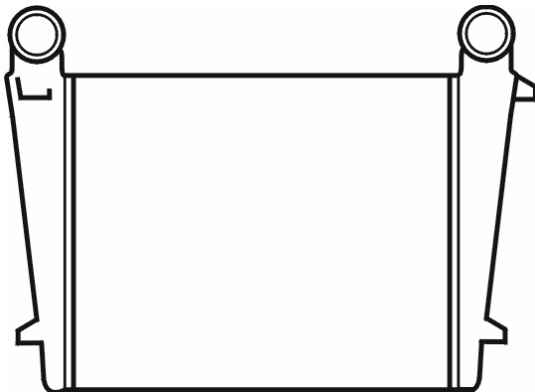

**Dimensional Data: MK16A**

INCHES	CORE SIZE	MM
28.346"	Width	720
25.196"	Height	640
N.A."	Core Thickness	N.A.
4.000"	Inlet Connection	100
4.000"	Outlet Connection	100

**Truck Type:**

Model	Years

**Replaces These OEM Part Numbers:**

Manufacturer	OEM #
Valeo	1030012
Western Star	222227-3402

**Ordering Information:**

	<b>AeroSeal</b>	<b>Turbo-Max</b>
Order #	MK16A-FA01	MK16A-FA02
Price		

Call To Order: 800-398-5471

Or visit our web site:

www.chargeaircoolers.com

**MACK**

**FLEET AIR PART #.....MK16B**

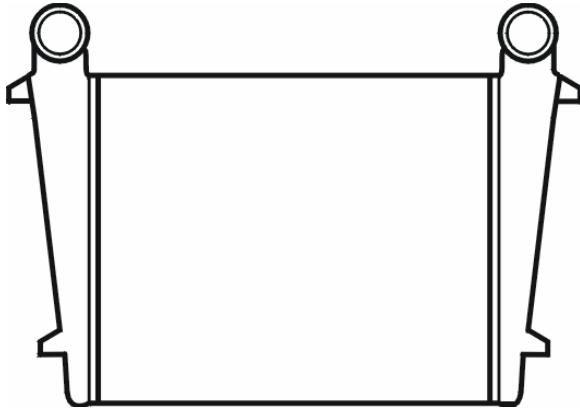

**Dimensional Data: MK16B**

INCHES	CORE SIZE	MM
28.346"	Width	720
25.196"	Height	640
N.A."	Core Thickness	N.A.
4.500"	Inlet Connection	114
4.125"	Outlet Connection	100

**Truck Type:**

Model	Years

**Replaces These OEM Part Numbers:**

Manufacturer	OEM #
N.A.	N.A.

**Ordering Information:**

	<b>AeroSeal</b>	<b>Turbo-Max</b>
Order #	MK16B-FA01	MK16B-FA02
Price		

**FLEET AIR PART #.....MK15A**



**Dimensional Data: MK15A**

INCHES	CORE SIZE	MM
30.000"	Width	762
24.566"	Height	624
2.250"	Core Thickness	57
4.000"	Inlet Connection	100
4.000"	Outlet Connection	100

**Truck Type:**

Model	Years
RD Mack	1991— Present

**Replaces These OEM Part Numbers:**

Manufacturer	OEM #
Mack	3MD538, 3MD538A, 3MD527A
Garrett	485-390-0001, 485-390-0002
Garrett	485-390-1, 485-390-5001
Mack	204SX278
Valeo	1030120

**Ordering Information:**

	<b>AeroSeal</b>	<b>Turbo-Max</b>
Order #	MK15A-FA01	MK15A-FA02
Price		

Call To Order: 800-398-5471

Or visit our web site:

www.chargeaircoolers.com

# MACK

## FLEET AIR PART #.....MK17A

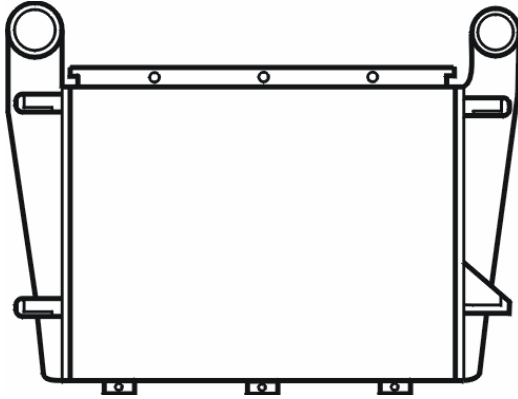

**Dimensional Data: MK17A**

INCHES	CORE SIZE	MM
30.500"	Width	775
25.157"	Height	639
2.750"	Core Thickness	69
4.000"	Inlet Connection	100
4.000"	Outlet Connection	100

### Truck Type:

Model	Years
R & U Model Mack	1983—1991
*interchangeable w/our MK17B	

### Replaces These OEM Part Numbers:

Manufacturer	OEM #
Mack	3MD13AC, 3MD53B, 3MD13A
Mack	3MD53, 3MD13AM, 3MD51B
Modine	IE 3022, IE 3085, IE 3194
Modine	IE 3408, IE 3524, IE 3589
Modine	IE 4014, IE 2787D, IE 3395

### Ordering Information:

	<b>AeroSeal</b>	<b>Turbo-Max</b>
Order #	MK17A-FA01	MK17A-FA02
Price		

## FLEET AIR PART #.....MK17B

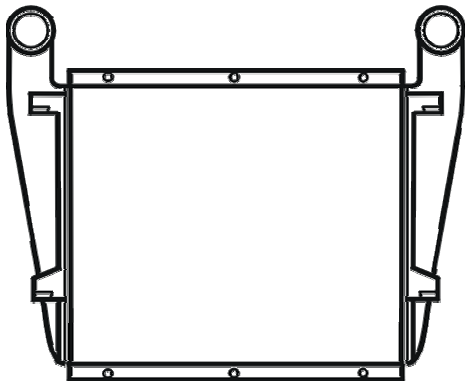

**Dimensional Data: MK17B**

INCHES	CORE SIZE	MM
30.125"	Width	765
25.250"	Height	641
2.750"	Core Thickness	69
4.000"	Inlet Connection	100
4.000"	Outlet Connection	100

### Truck Type:

Model	Years
R & U Model Mack	1983—1991

### Replaces These OEM Part Numbers:

Manufacturer	OEM #
Garrett	464-420-2
Garrett	464-420-8
Garrett	491-720-4

### Ordering Information:

	<b>AeroSeal</b>	<b>Turbo-Max</b>
Order #	MK17B-FA01	MK17B-FA02
Price		

Call To Order: 800-398-5471

Or visit our web site:

www.chargeaircoolers.com

# MACK

## FLEET AIR PART #.....MK17C

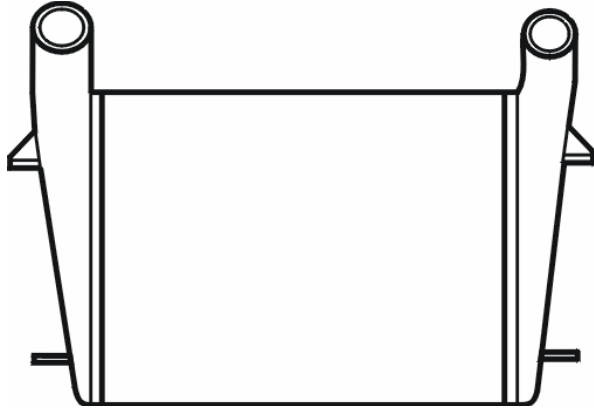

**Dimensional Data: MK17C**

INCHES	CORE SIZE	MM
27.875"	Width	708
24.687"	Height	627
2.750"	Core Thickness	69
4.000"	Inlet Connection	100
4.000"	Outlet Connection	100

### Truck Type:

Model	Years
Cruiseliners	

### Replaces These OEM Part Numbers:

Manufacturer	OEM #
Mack	3MD59301
Garrett	464-410-2

### Ordering Information:

	<b>AeroSeal</b>	<b>Turbo-Max</b>
Order #	MK17C-FA01	MK17C-FA02
Price		

## FLEET AIR PART #.....MK18A



**Dimensional Data: MK18A**

INCHES	CORE SIZE	MM
39.370"	Width	1000
21.692"	Height	551
2.625"	Core Thickness	66
3.750"	Inlet Connection	95
3.750"	Outlet Connection	95

### Truck Type:

Model	Years
CH Mack w/ E6 & E7 Engine	1987—1994

### Replaces These OEM Part Numbers:

Manufacturer	OEM #
Modine	IE 3515, IE 3394, IE 3170
Mack	3MD16MA, 3MD516AM
Mack	3MD516BM, 3MD516M

### Ordering Information:

	<b>AeroSeal</b>	<b>Turbo-Max</b>
Order #	MK18A-FA01	MK18A-FA02
Price		

Call To Order: 800-398-5471

Or visit our web site:

www.chargeaircoolers.com

# MACK

## FLEET AIR PART #.....MK18B

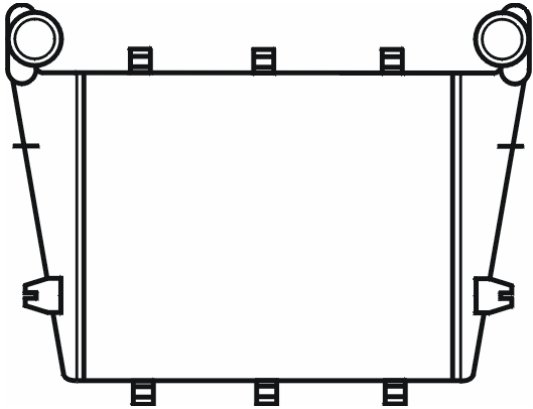

**Dimensional Data: MK18B**

INCHES	CORE SIZE	MM
30.157"	Width	766
25.866"	Height	657
2.250"	Core Thickness	57
4.000"	Inlet Connection	100
4.000"	Outlet Connection	100

### Truck Type:

Model	Years
RD Model Mack	1987—1990

### Replaces These OEM Part Numbers:

Manufacturer	OEM #
Mack	3MD512, 3MD519, 3MD519A
Garrett	493-740-0001, 493-740-0002
Garrett	493-740-1, 493-740-5001
Garrett	493-740-5002, 493-740-5004

### Ordering Information:

	<b>AeroSeal</b>	<b>Turbo-Max</b>
Order #	MK18B-FA01	MK18B-FA02
Price		

## FLEET AIR PART #.....MK18D



**Dimensional Data: MK18D**

INCHES	CORE SIZE	MM
35.812"	Width	909
21.500"	Height	546
3.000"	Core Thickness	75
3.125"	Inlet Connection	79
3.125"	Outlet Connection	79

### Truck Type:

Model	Years

### Replaces These OEM Part Numbers:

Manufacturer	OEM #
Garrett	464-090-1
Mack	3MD45
Mack	3MD422

### Ordering Information:

	<b>AeroSeal</b>	<b>Turbo-Max</b>
Order #	MK18D-FA01	MK18D-FA02
Price		

Call To Order: 800-398-5471

Or visit our web site:

www.chargeaircoolers.com

**MACK**

**FLEET AIR PART #.....MK18E**

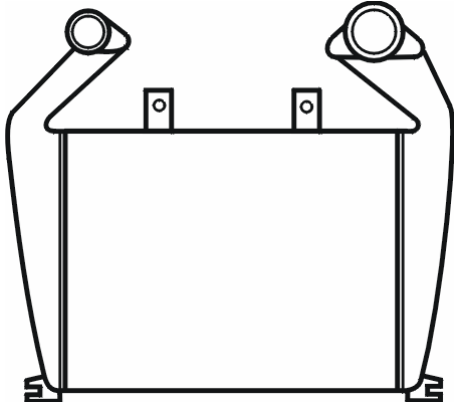

**Dimensional Data: MK18E**

INCHES	CORE SIZE	MM
23.503"	Width	597
18.464"	Height	469
2.750"	Core Thickness	69
4.000"	Inlet Connection	100
3.000"	Outlet Connection	75

**Truck Type:**

Model	Years
Trash Truck	

**Replaces These OEM Part Numbers:**

Manufacturer	OEM #
Mack	3MD518
Mack	3MD511BP2 (also see MK18E3)
Garrett	493-334-0002
Garrett	493-890-1

**Ordering Information:**

	<b>AeroSeal</b>	<b>Turbo-Max</b>
Order #	MK18E-FA01	MK18E-FA02
Price		

**FLEET AIR PART #.....MK18E2**

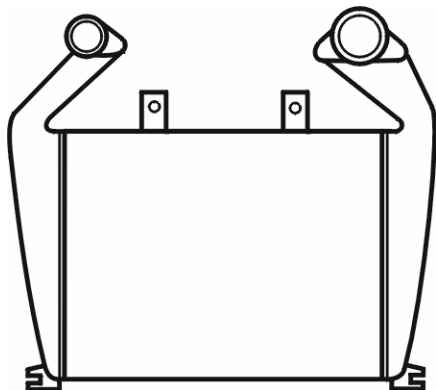

**Dimensional Data: MK18E2**

INCHES	CORE SIZE	MM
23.503"	Width	597
18.464"	Height	469
3.500"	Core Thickness	88
4.000"	Inlet Connection	100
3.000"	Outlet Connection	75

**Truck Type:**

Model	Years
Trash Truck	

**Replaces These OEM Part Numbers:**

Manufacturer	OEM #
Garrett	493-334-0002

**Ordering Information:**

	<b>AeroSeal</b>	<b>Turbo-Max</b>
Order #	MK18E2-FA01	MK18E2-FA02
Price		

Call To Order: 800-398-5471

Or visit our web site:

www.chargeaircoolers.com

**MACK**

**FLEET AIR PART #.....MK18E3**

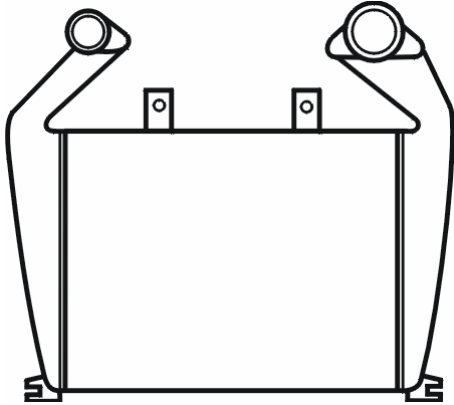

**Dimensional Data: MK18E3**

INCHES	CORE SIZE	MM
23.503"	Width	597
18.464"	Height	469
4.000"	Core Thickness	100
4.000"	Inlet Connection	100
3.000"	Outlet Connection	75

**Truck Type:**

Model	Years
Trash Truck	

**Replaces These OEM Part Numbers:**

Manufacturer	OEM #
Mack	3MD511BP2 (also see MK18E)

**Ordering Information:**

	<b>AeroSeal</b>	<b>Turbo-Max</b>
Order #	MK18E3-FA01	MK18E3-FA02
Price		

**FLEET AIR PART #.....MK18E4**

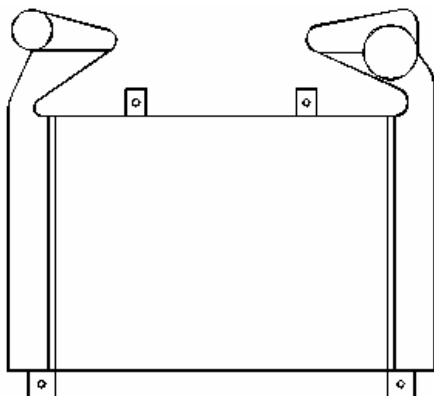

**Dimensional Data: MK18E4**

INCHES	CORE SIZE	MM
23.503"	Width	597
18.464"	Height	469
2.750"	Core Thickness	69
4.000"	Inlet Connection	100
3.000"	Outlet Connection	75

**Truck Type:**

Model	Years
LE Series /Trash Truck / New Style	
Outlet side tank comes straight out, Inlet side comes out then angles down.	

**Replaces These OEM Part Numbers:**

Manufacturer	OEM #
Mack	3MD531
Valeo	817165
Valeo	1030170

**Ordering Information:**

	<b>AeroSeal</b>	<b>Turbo-Max</b>
Order #	MK18E4-FA01	MK18E4-FA02
Price		

Call To Order: 800-398-5471

Or visit our web site:

www.chargeaircoolers.com

**MACK**

**FLEET AIR PART #.....MK18E5**

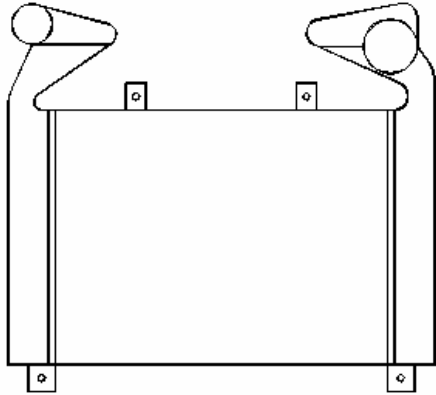

**Dimensional Data: MK18E5**

INCHES	CORE SIZE	MM
23.503"	Width	597
18.464"	Height	469
2.750"	Core Thickness	69
4.000"	Inlet Connection	100
3.000"	Outlet Connection	75

**Truck Type:**

Model	Years
Trash Truck / New Style	
Outlet side tank slightly higher w/ a small upward then downward curve.	

**Replaces These OEM Part Numbers:**

Manufacturer	OEM #
Mack	3MD539
Mack	11303001

**Ordering Information:**

	<b>AeroSeal</b>	<b>Turbo-Max</b>
Order #	MK18E5-FA01	MK18E5-FA02
Price		

**FLEET AIR PART #.....**

**Truck Type:**

Model	Years

**Replaces These OEM Part Numbers:**

Manufacturer	OEM #

**Ordering Information:**

	<b>AeroSeal</b>	<b>Turbo-Max</b>
Order #		
Price		

**Dimensional Data:**

INCHES	CORE SIZE	MM
0.000"	Width	0
0.000"	Height	0
0.000"	Core Thickness	0
0.000"	Inlet Connection	0
0.000"	Outlet Connection	0

Call To Order: 800-398-5471

Or visit our web site:

www.chargeaircoolers.com

# MACK

## FLEET AIR PART #.....MK18F

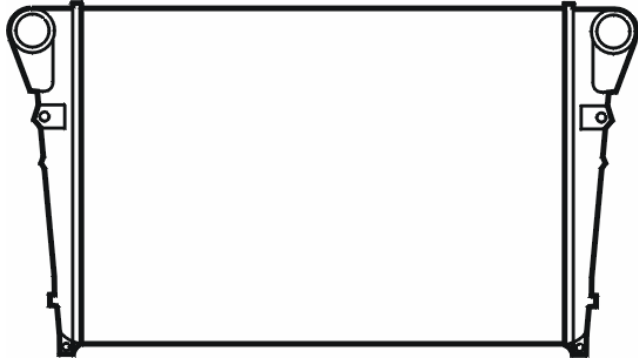

### Dimensional Data: MK18F

INCHES	CORE SIZE	MM
38.188"	Width	970
27.283"	Height	693
2.500"	Core Thickness	63
3.500"	Inlet Connection	88
3.500"	Outlet Connection	88

### Truck Type:

Model	Years
CH w/V-Mack Engine	1995—Present

### Replaces These OEM Part Numbers:

Manufacturer	OEM #
Valeo	1030091
Valeo	817131
Mack	3MD532M
Mack	3MD532AM

### Ordering Information:

	<b>AeroSeal</b>	<b>Turbo-Max</b>
Order #	MK18F-FA01	MK18F-FA02
Price		

## FLEET AIR PART #.....MK18G

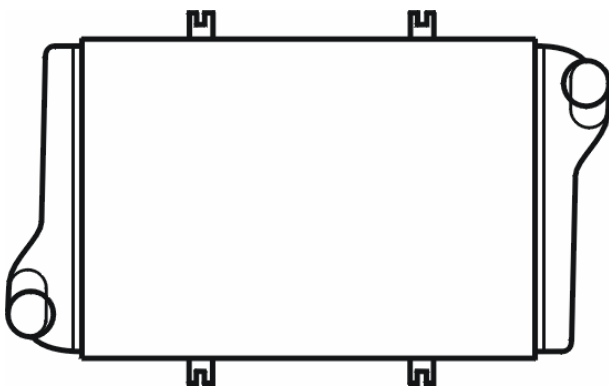

### Dimensional Data: MK18G

INCHES	CORE SIZE	MM
32.500"	Width	825
22.625"	Height	574
N.A."	Core Thickness	N.A.
3.687"	Inlet Connection	93
3.687"	Outlet Connection	93

### Truck Type:

Model	Years

### Replaces These OEM Part Numbers:

Manufacturer	OEM #
Garrett	493-970-3
Mack	3MD532M

### Ordering Information:

	<b>AeroSeal</b>	<b>Turbo-Max</b>
Order #	MK18G-FA01	MK18G-FA02
Price		

Call To Order: 800-398-5471

Or visit our web site:

www.chargeaircoolers.com

**MACK**

**FLEET AIR PART #.....MK18I**



**Dimensional Data: MK18I**

INCHES	CORE SIZE	MM
33.875"	Width	860
21.000"	Height	533
N.A."	Core Thickness	N.A.
4.000"	Inlet Connection	100
4.000"	Outlet Connection	100

**Truck Type:**

Model	Years

**Replaces These OEM Part Numbers:**

Manufacturer	OEM #
Mack	3MD515
Garrett	493-750-0001

**Ordering Information:**

	<b>AeroSeal</b>	<b>Turbo-Max</b>
Order #	MK18I-FA01	MK18I-FA02
Price		

**FLEET AIR PART #.....MK18J**

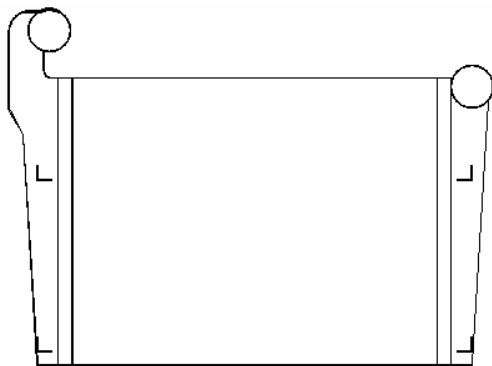

**Dimensional Data: MK18J**

INCHES	CORE SIZE	MM
26.500"	Width	663
20.375"	Height	510
2.000"	Core Thickness	50
3.250"	Inlet Connection	82
3.250"	Outlet Connection	82

**Truck Type:**

Model	Years

**Replaces These OEM Part Numbers:**

Manufacturer	OEM #
G & O	62E00464301
G & O	083446431
G & O	Z37E00464301
G & O	31E00464310

**Ordering Information:**

	<b>AeroSeal</b>	<b>Turbo-Max</b>
Order #	MK18J-FA01	MK18J-FA02
Price		

Call To Order: 800-398-5471

Or visit our web site:

www.chargeaircoolers.com

# MACK

## FLEET AIR PART #.....MK18L

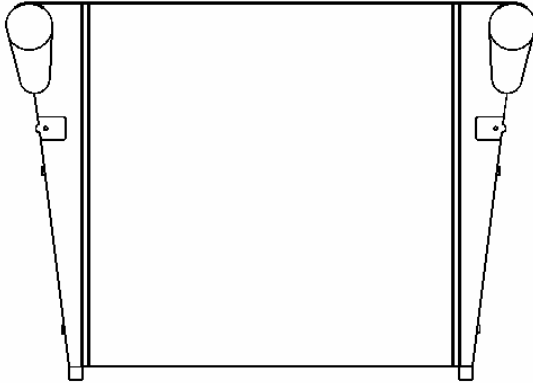

**Dimensional Data: MK18L**

INCHES	CORE SIZE	MM
27.250"	Width	682
27.283"	Height	693
2.500"	Core Thickness	63
3.500"	Inlet Connection	100
3.500"	Outlet Connection	100

### Truck Type:

Model	Years
CX Model MK	

### Replaces These OEM Part Numbers:

Manufacturer	OEM #
N.A.	N.A.

### Ordering Information:

	<b>AeroSeal</b>	<b>Turbo-Max</b>
Order #	MK18L-FA01	MK18L-FA02
Price		

## FLEET AIR PART #.....MK19A

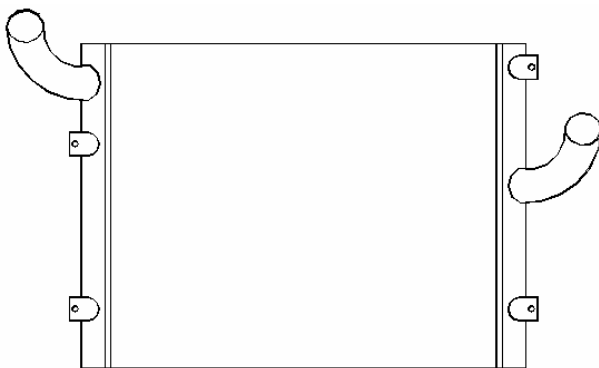

**Dimensional Data: MK19A**

INCHES	CORE SIZE	MM
32.750"	Width	819
27.500"	Height	688
N.A."	Core Thickness	N.A.
3.250"	Inlet Connection	82
3.250"	Outlet Connection	82

### Truck Type:

Model	Years
Mack Superliner	1982

### Replaces These OEM Part Numbers:

Manufacturer	OEM #
Mack	1MD49528

### Ordering Information:

	<b>AeroSeal</b>	<b>Turbo-Max</b>
Order #	MK19A-FA01	MK19A-FA02
Price		