

Call To Order: 800-398-5471

Or visit our web site:

www.chargeaircoolers.com

FORD

FLEET AIR PART #.....FD25A

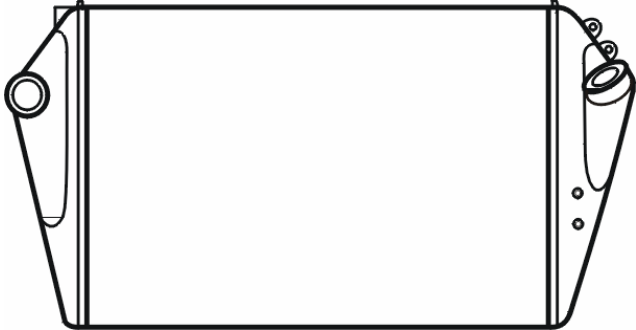

Dimensional Data: FD25A

INCHES	CORE SIZE	MM
39.370"	Width	1000
27.204"	Height	691
1.625"	Core Thickness	41
4.500"	Inlet Connection	114
4.000"	Outlet Connection	100

Truck Type:

Model	Years
LTL 8000 & 9000 Aeromax	Up to 1994
With condenser & oil cooler mounts	

Replaces These OEM Part Numbers:

Manufacturer	OEM #
Ford	F8HT14A284AC, FOHZ6K775A
Ford	F4KZ6K775B, E9HZ6K775C
Thermag	200500, 200520
Modine	IE 3396, IE 3436, IE 3246, IE 3507
Modine	IE 3708, IE 3709, IE 3710, IE 3539

Ordering Information:

	AeroSeal	Turbo-Max
Order #	FD25A-FA01	FD25A-FA02
Price		

FLEET AIR PART #.....FD25C



Dimensional Data: FD25C

INCHES	CORE SIZE	MM
39.370"	Width	1000
27.204"	Height	691
1.625"	Core Thickness	41
4.000"	Inlet Connection	100
4.000"	Outlet Connection	100

Truck Type:

Model	Years
L9000 Day Cab	Up to 1994
Has straight 4" inlet/outlet	

Replaces These OEM Part Numbers:

Manufacturer	OEM #
Ford	E8HT6K775FB, F3HZ6K775E
Ford	FOHZ6K775C, E9HZ6K775A
Modine	IE 3249, IE 3715, IE 3714
Thermag	200521, 201800

Ordering Information:

	AeroSeal	Turbo-Max
Order #	FD25C-FA01	FD25C-FA02
Price		

Call To Order: 800-398-5471

Or visit our web site:

www.chargeaircoolers.com

FORD

FLEET AIR PART #.....FD25B



Dimensional Data: FD25B

INCHES	CORE SIZE	MM
39.370"	Width	1000
27.204"	Height	691
1.625"	Core Thickness	41
3.000"	Inlet Connection	75
3.000"	Outlet Connection	75

Truck Type:

Model	Years
L8000	Up to 1994

Replaces These OEM Part Numbers:

Manufacturer	OEM #
Ford	E8TH6K775ED, E8HZ6K775G
Ford	FOHT6K775EA, FOHT6K775HA
Ford	EDE8HT6K775EC, F3HZ6K775J
Modine	IE 3248, IE 3526, IE 3716, IE 3717
Thermag	202800, 202821

Ordering Information:

	AeroSeal	Turbo-Max
Order #	FD25B-FA01	FD25B-FA02
Price		

FLEET AIR PART #.....FD25D

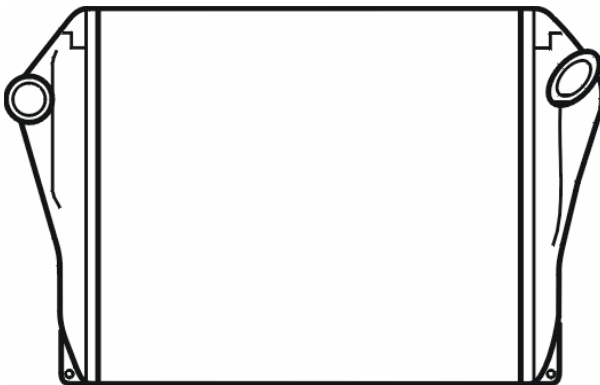

Dimensional Data: FD25D

INCHES	CORE SIZE	MM
35.250"	Width	895
33.500"	Height	850
2.500"	Core Thickness	63
4.500"	Inlet Connection	114
4.000"	Outlet Connection	100

Truck Type:

Model	Years

Replaces These OEM Part Numbers:

Manufacturer	OEM #
Ford	F4HT8009FC, F4HT8009FB
Ford	F4HZ6K775C, F5HT8009SA
Valeo	1003247, 1030083

Ordering Information:

	AeroSeal	Turbo-Max
Order #	FD25D-FA01	FD25D-FA02
Price		

Call To Order: 800-398-5471

Or visit our web site:

www.chargeaircoolers.com

FORD

FLEET AIR PART #.....FD250



Dimensional Data: FD250

INCHES	CORE SIZE	MM
35.250"	Width	895
33.500"	Height	850
2.500"	Core Thickness	63
4.500"	Inlet Connection	114
4.000"	Outlet Connection	100

Truck Type:

Model	Years

Replaces These OEM Part Numbers:

Manufacturer	OEM #
Ford	F6HZ6K775HA, F6KT8009EE
Ford	F6HZ6K775HA, F8HT8009HA
Valeo	1030097, 1040001
Valeo	1030226
Valeo	ZAL1040111

Ordering Information:

	AeroSeal	Turbo-Max
Order #	FD250-FA01	FD250-FA02
Price		

FLEET AIR PART #.....FD25F



Dimensional Data: FD25F

INCHES	CORE SIZE	MM
35.236"	Width	896
27.283"	Height	693
2.500"	Core Thickness	63
4.500"	Inlet Connection	114
4.000"	Outlet Connection	100

Truck Type:

Model	Years
L9000 / Aero Max	1995 and up

Replaces These OEM Part Numbers:

Manufacturer	OEM #
Ford	F5HT8009LA, F5HT8009NA
Ford	F4HT8009AC, F4HT8009CB
Ford	F5HT8009ABA, F4HZ6K775B
Valeo	1003241, 1003265, 1003271
Valeo	1003273, 1030113, 160327, 1030112

Ordering Information:

	AeroSeal	Turbo-Max
Order #	FD25F-FA01	FD25F-FA02
Price		

Call To Order: 800-398-5471

Or visit our web site:

www.chargeaircoolers.com

FORD

FLEET AIR PART #.....FD25H



Dimensional Data: FD25H

INCHES	CORE SIZE	MM
35.236"	Width	896
27.283"	Height	693
2.500"	Core Thickness	63
4.000"	Inlet Connection	114
4.000"	Outlet Connection	100

Truck Type:

Model	Years
L8000 Day Cab	1995 and up

Replaces These OEM Part Numbers:

Manufacturer	OEM #
Ford	F4HT8009LC, F5HT8009TA
Ford	F5HT8009AAA, F8HT8009GA
Ford	F5HT8009A
Valeo	1003263, 1003366, 1030090

Ordering Information:

	AeroSeal	Turbo-Max
Order #	FD25H-FA01	FD25H-FA02
Price		

FLEET AIR PART #.....FD25M



Dimensional Data: FD25M

INCHES	CORE SIZE	MM
35.236"	Width	896
27.283"	Height	693
2.500"	Core Thickness	63
4.500"	Inlet Connection	114
4.000"	Outlet Connection	100

Truck Type:

Model	Years
Sterling	1998 and up

Replaces These OEM Part Numbers:

Manufacturer	OEM #
Ford	F7HZ6K775BA, F8HT8009TA
Ford	F7HT8009CE, F7HZ6K775AA
Valeo	1030228, 1030118, 1030138
Valeo	1040019, 1040018
Ford	F7HT8009BE, F8HT8009UA

Ordering Information:

	AeroSeal	Turbo-Max
Order #	FD25M-FA01	FD25M-FA02
Price		

Call To Order: 800-398-5471

Or visit our web site:

www.chargeaircoolers.com

FORD

FLEET AIR PART #.....FD25N



Dimensional Data: FD25N

INCHES	CORE SIZE	MM
35.236"	Width	895
27.283"	Height	850
2.500"	Core Thickness	63
4.500"	Inlet Connection	114
4.000"	Outlet Connection	100

Truck Type:

Model	Years
Sterling	1998 and up

Replaces These OEM Part Numbers:

Manufacturer	OEM #
Ford	F4HZ6K775A, F6HZ6K775GA
Valeo	1030098, 1040002, 1030099
Valeo	1030227, 1040024, 1040063
Ford	04723IL
Valeo	1040003, 1040025, 1040111

Ordering Information:

	AeroSeal	Turbo-Max
Order #	FD25N-FA01	FD25N-FA02
Price		

FLEET AIR PART #.....FD25N2

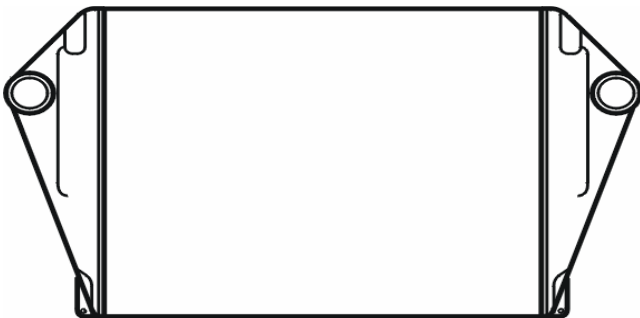

Dimensional Data: FD25N2

INCHES	CORE SIZE	MM
35.250"	Width	882
23.750"	Height	594
2.500"	Core Thickness	63
4.500"	Inlet Connection	114
4.000"	Outlet Connection	100

Truck Type:

Model	Years

Replaces These OEM Part Numbers:

Manufacturer	OEM #
Ford	F8HT8009EA, F6HT8009BB
Valeo	1030245, 1040040, 1040008
Valeo	1030161, 1030133, 1030249
Ford	F6HZ6K775FA
Valeo	1030245

Ordering Information:

	AeroSeal	Turbo-Max
Order #	FD25N2-FA01	FD25N2-FA02
Price		

Call To Order: 800-398-5471

Or visit our web site:

www.chargeaircoolers.com

FORD

FLEET AIR PART #.....FD25G

Truck Type:

Model	Years
FMJ	

Replaces These OEM Part Numbers:

Manufacturer	OEM #
Ford	FSHT8009YB, F4HT8009TB
Ford	F4HT8009TD, F4HZ6K775F
Ford	F5HT8009YB, F5HT8009ZB
Valeo	1003304, 1030104, 1040050
Valeo	1003306, 1040043



Dimensional Data: FD25G

INCHES	CORE SIZE	MM
32.283"	Width	820
25.500"	Height	647
2.500"	Core Thickness	63
3.000"	Inlet Connection	76
3.375"	Outlet Connection	85

Ordering Information:

	AeroSeal	Turbo-Max
Order #	FD25G-FA01	FD25G-FA02
Price		

FLEET AIR PART #.....FD25L

Truck Type:

Model	Years
LT8501	
FMJ	

Replaces These OEM Part Numbers:

Manufacturer	OEM #
Ford	F7HT8009ATA, F7HT8009BCA
Ford	F8HT8009CA, F6HT8009AKD
Ford	F4HT8009ARA, F7HZ8009BNA
Valeo	1040014, 1040043, 1040017
Valeo	105001, 1030100, 1040016

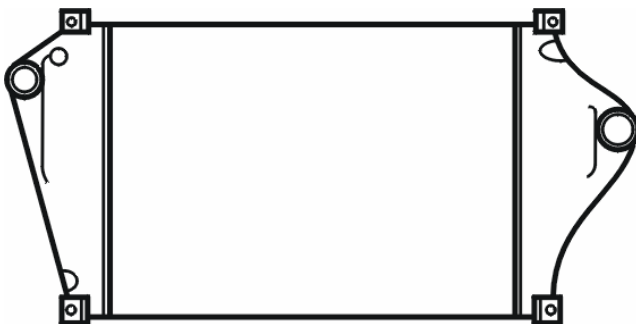

Dimensional Data: FD25L

INCHES	CORE SIZE	MM
32.250"	Width	819
23.625"	Height	600
2.500"	Core Thickness	63
3.500"	Inlet Connection	88
3.125"	Outlet Connection	79

Ordering Information:

	AeroSeal	Turbo-Max
Order #	FD25L-FA01	FD25L-FA02
Price		

Call To Order: 800-398-5471

Or visit our web site:

www.chargeaircoolers.com

FORD

FLEET AIR PART #.....FD25J

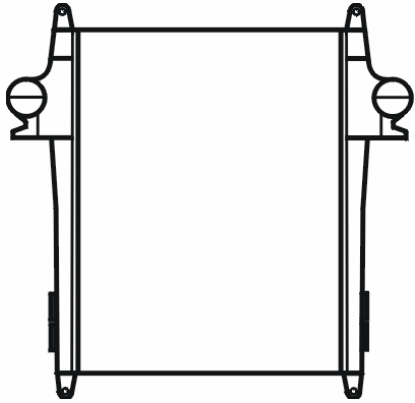

Dimensional Data: FD25J

INCHES	CORE SIZE	MM
21.000"	Width	533
27.750"	Height	704
N.A."	Core Thickness	N.A.
3.125"	Inlet Connection	79
3.125"	Outlet Connection	79

Truck Type:

Model	Years
Ford Cargo	

Replaces These OEM Part Numbers:

Manufacturer	OEM #
Ford	F2HT6K775AA, F3HT6K775HA
Modine	IE 3541, IE 3632

Ordering Information:

	AeroSeal	Turbo-Max
Order #	FD25J-FA01	FD25J-FA02
Price		

FLEET AIR PART #.....FD27A

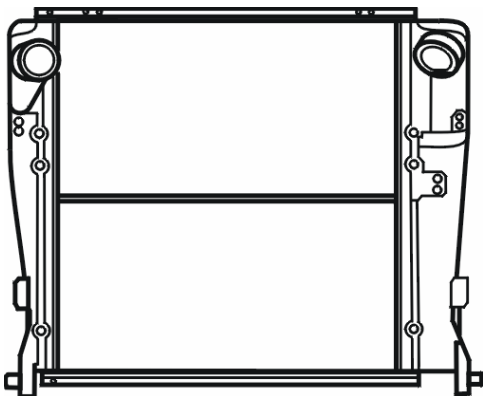

Dimensional Data: FD27A

INCHES	CORE SIZE	MM
28.031"	Width	712
2X18.937"	Height	964
N.A."	Core Thickness	N.A.
4.500"	Inlet Connection	114
4.500"	Outlet Connection	114

Truck Type:

Model	Years
Cabover	

Replaces These OEM Part Numbers:

Manufacturer	OEM #
Ford	F8HT6K775D, F8TH6K775DD
Ford	E8HZ6K775D, F1HT6K775AA
Modine	IE 3247, IE 3462
Thermag	200600, 200697

Ordering Information:

	AeroSeal	Turbo-Max
Order #	FD27A-FA01	FD27A-FA02
Price		

Call To Order: 800-398-5471

Or visit our web site:

www.chargeaircoolers.com

FORD

FLEET AIR PART #.....FD26B



Dimensional Data: FD26B

INCHES	CORE SIZE	MM
27.559"	Width	700
20.039"	Height	509
1.625"	Core Thickness	41
3.000"	Inlet Connection	75
3.000"	Outlet Connection	75

Truck Type:

Model	Years
F700 / F800 / F900	
F & B Series	

Replaces These OEM Part Numbers:

Manufacturer	OEM #
Ford	F3HZ6K775A, FOHT6K775GA
Ford	FOHZ6K775E, F3HT6K775BB
Ford	E7HT6K775AD
Thermag	200300
Modine	IE 3250

Ordering Information:

	AeroSeal	Turbo-Max
Order #	FD26B-FA01	FD26B-FA02
Price		

FLEET AIR PART #.....FD26B2



Dimensional Data: FD26B2

INCHES	CORE SIZE	MM
27.559"	Width	700
20.039"	Height	509
3.500"	Core Thickness	88
3.000"	Inlet Connection	75
3.000"	Outlet Connection	75

Truck Type:

Model	Years
F & B Series Cummins "C"	
F & B Series with 8.3L Diesel	

Replaces These OEM Part Numbers:

Manufacturer	OEM #
Ford	F3HZ6K775K, F3HT6K775ED
Ford	F3HT6K775D, F6HZ6K775AA
Modine	IE 3472, IE 3666
Ford	F3HT6K775EB

Ordering Information:

	AeroSeal	Turbo-Max
Order #	FD26B2-FA01	FD26B2-FA02
Price		

Call To Order: 800-398-5471

Or visit our web site:

www.chargeaircoolers.com

FORD

FLEET AIR PART #.....FD26B3

Truck Type:

Model	Years
F700 / F800 / F900	
F & B Series with 5.9L Diesel	

Replaces These OEM Part Numbers:

Manufacturer	OEM #
Ford	F3HT6K775BB
Modine	IE 3514



Dimensional Data: FD26B3

INCHES	CORE SIZE	MM
27.559"	Width	700
20.039"	Height	509
2.625"	Core Thickness	66
3.000"	Inlet Connection	75
3.000"	Outlet Connection	75

Ordering Information:

	AeroSeal	Turbo-Max
Order #	FD26B3-FA01	FD26B3-FA02
Price		

FLEET AIR PART #.....

Truck Type:

Model	Years

Replaces These OEM Part Numbers:

Manufacturer	OEM #

Dimensional Data:

INCHES	CORE SIZE	MM
0.000"	Width	0
0.000"	Height	0
0.000"	Core Thickness	0
0.000"	Inlet Connection	0
0.000"	Outlet Connection	0

Ordering Information:

	AeroSeal	Turbo-Max
Order #		
Price		

Call To Order: 800-398-5471

Or visit our web site:

www.chargeaircoolers.com

FORD

FLEET AIR PART #.....FD26A

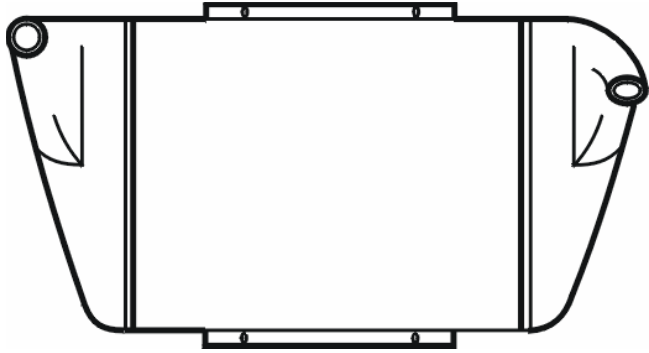

Dimensional Data: FD26A

INCHES	CORE SIZE	MM
30.708"	Width	780
25.551"	Height	649
1.625"	Core Thickness	41
3.500"	Inlet Connection	88
3.500"	Outlet Connection	88

Truck Type:

Model	Years
L8000 Brazilian Engine	1987

Replaces These OEM Part Numbers:

Manufacturer	OEM #
Ford	E7HZ6K775G, E7HZ6K775E
Ford	EDE7HT6K775BC, EYHZ6K775G
Thermag	200400, 200420, 200421, 200497
Thermag	201497, 2200497
Modine	IE 3252, IE 3592

Ordering Information:

	AeroSeal	Turbo-Max
Order #	FD26A-FA01	FD26A-FA02
Price		

FLEET AIR PART #.....FD25E

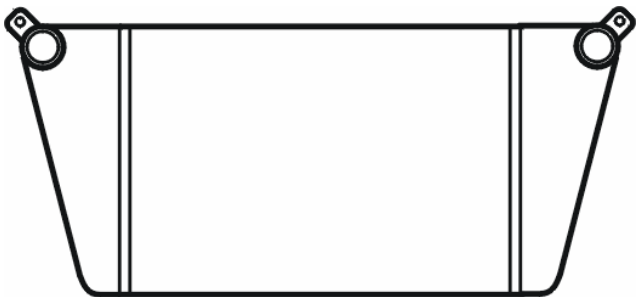

Dimensional Data: FD25E

INCHES	CORE SIZE	MM
24.500"	Width	622
18.125"	Height	460
N.A."	Core Thickness	N.A.
2.875"	Inlet Connection	73
2.875"	Outlet Connection	73

Truck Type:

Model	Years

Replaces These OEM Part Numbers:

Manufacturer	OEM #
Ford	F8HT6K775HA
Modine	IE 3642
Valeo	1003371

Ordering Information:

	AeroSeal	Turbo-Max
Order #	FD25E-FA01	FD25E-FA02
Price		

Call To Order: 800-398-5471

Or visit our web site:

www.chargeaircoolers.com

FORD

FLEET AIR PART #.....FD26C

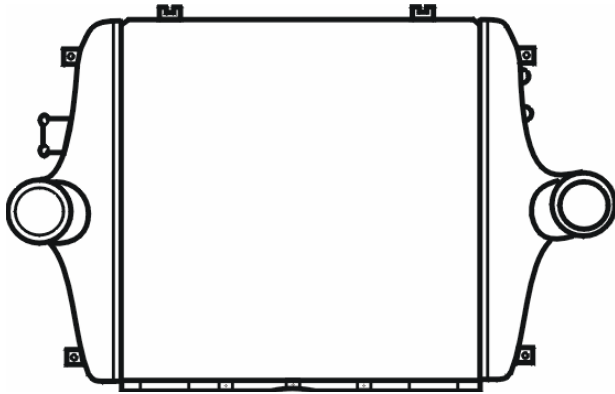

Dimensional Data: FD26C

INCHES	CORE SIZE	MM
29.724"	Width	755
27.165"	Height	690
1.750"	Core Thickness	44
3.000"	Inlet Connection	75
3.000"	Outlet Connection	75

Truck Type:

Model	Years
F800	

Replaces These OEM Part Numbers:

Manufacturer	OEM #
Ford	F5HZ6K775A

Ordering Information:

	AeroSeal	Turbo-Max
Order #	FD26C-FA01	FD26C-FA02
Price		

FLEET AIR PART #.....FD26C2

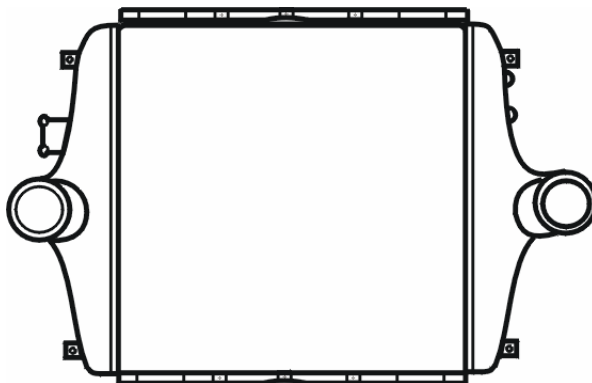

Dimensional Data: FD26C2

INCHES	CORE SIZE	MM
29.625"	Width	741
26.000"	Height	650
1.625"	Core Thickness	41
3.125"	Inlet Connection	79
3.125"	Outlet Connection	79

Truck Type:

Model	Years
F750	Around the 2000's
3126 Cat Engine	

Replaces These OEM Part Numbers:

Manufacturer	OEM #
Ford	X23Z6K775AA
Ford	XZ3Z6K775AA
Ford	XC3Z6K775AA

Ordering Information:

	AeroSeal	Turbo-Max
Order #	FD26C2-FA01	FD26C2-FA02
Price		

Call To Order: 800-398-5471

Or visit our web site:

www.chargeaircoolers.com

FORD

FLEET AIR PART #.....FD25K

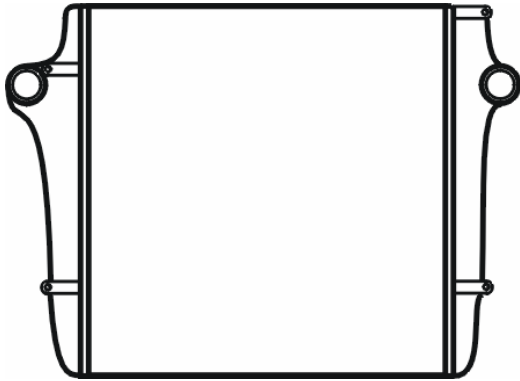

Dimensional Data: FD25K

INCHES	CORE SIZE	MM
23.070"	Width	586
25.236"	Height	641
1.625"	Core Thickness	41
3.000"	Inlet Connection	75
3.000"	Outlet Connection	75

Truck Type:

Model	Years

Replaces These OEM Part Numbers:

Manufacturer	OEM #
Thermag	200700
Ford	E7HU6K775AB

Ordering Information:

	AeroSeal	Turbo-Max
Order #	FD25K-FA01	FD25K-FA02
Price		

FLEET AIR PART #.....FD25N3

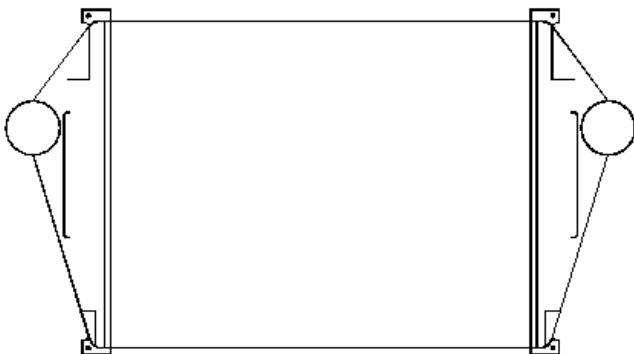

Dimensional Data: FD25N3

INCHES	CORE SIZE	MM
35.250"	Width	885
23.500"	Height	667
2.500"	Core Thickness	63
4.500"	Inlet Connection	114
4.000"	Outlet Connection	100

Truck Type:

Model	Years

Replaces These OEM Part Numbers:

Manufacturer	OEM #
N.A.	N.A.

Ordering Information:

	AeroSeal	Turbo-Max
Order #	FD25N3-FA01	FD25N3-FA02
Price		

Call To Order: 800-398-5471

Or visit our web site:

www.chargeaircoolers.com

FORD

FLEET AIR PART #.....FD25Q

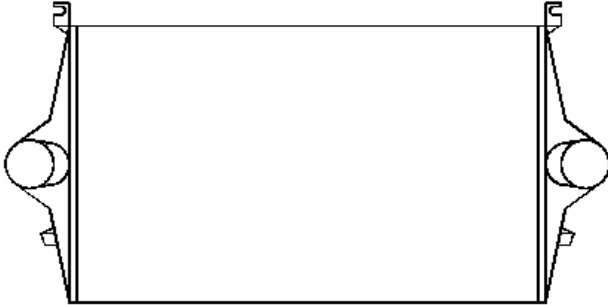

Dimensional Data: FD25Q

INCHES	CORE SIZE	MM
29.875"	Width	747
17.875"	Height	447
2.000"	Core Thickness	50
3.375"	Inlet Connection	85
3.375"	Outlet Connection	85

Truck Type:

Model	Years
F-250 to F-550 Power Stroke	

Replaces These OEM Part Numbers:

Manufacturer	OEM #
Ford	F81A6K775BA, 1C3Z6K775AA
Ford	YC3566K775AA, F81Z6K775AA
Valeo	1030128, 1030193, 1030207
Valeo	1030218

Ordering Information:

	AeroSeal	Turbo-Max
Order #	FD25Q-FA01	FD25Q-FA02
Price		

FLEET AIR PART #.....FD25I

Truck Type:

Model	Years

Replaces These OEM Part Numbers:

Manufacturer	OEM #
Valeo	1030088

Ordering Information:

	AeroSeal	Turbo-Max
Order #	FD25I-FA01	FD25I-FA02
Price		

Dimensional Data: FD25I

INCHES	CORE SIZE	MM
N.A."	Width	N.A.
N.A."	Height	N.A.
N.A."	Core Thickness	N.A.
N.A."	Inlet Connection	N.A.
N.A."	Outlet Connection	N.A.